



2x



2x
Yellow



2x
Bright orange



2x
Green



2x
White



2x
White



4x
White



2x
Red



2x
Red

1

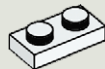

2

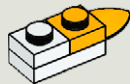

3

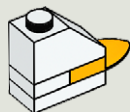

4

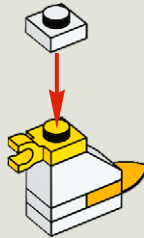

5

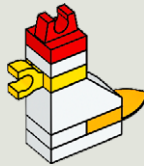

6

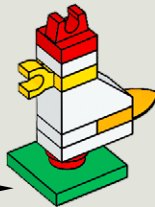
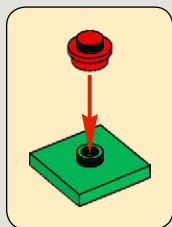

2x

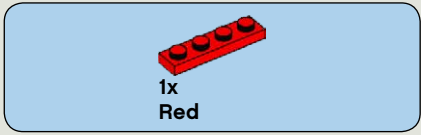
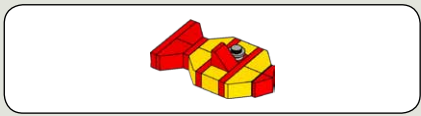

1

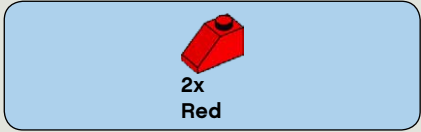

2

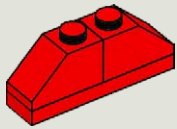

3

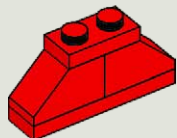

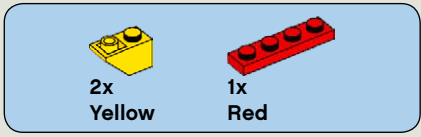

4

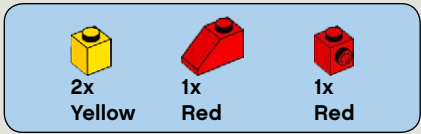
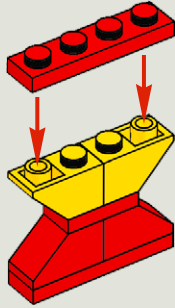

5

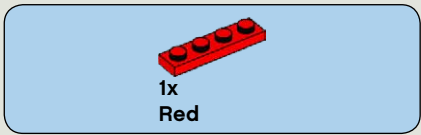
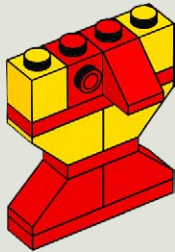

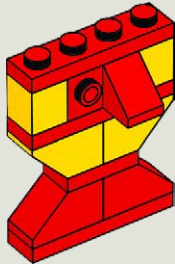

6



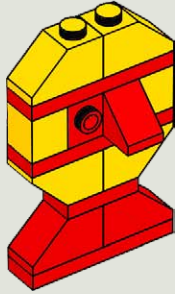

2x
Yellow

7



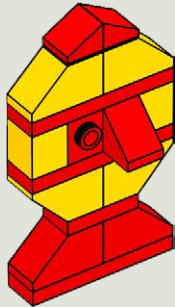

2x
Red

8



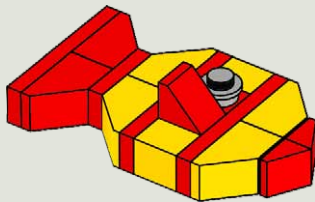

1x
Medium grey

9

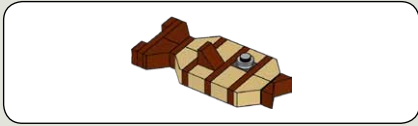

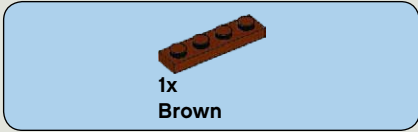
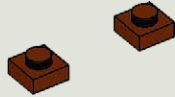

1



2

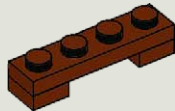

3

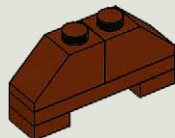



4

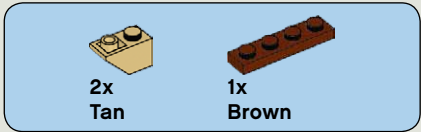
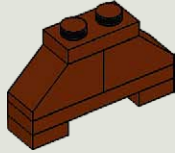

5

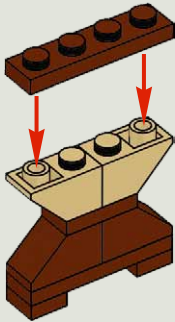

6

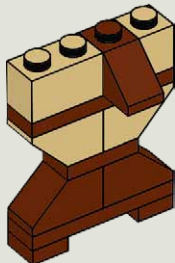

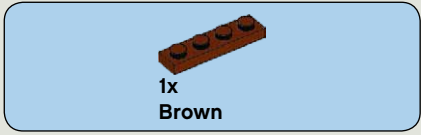

7

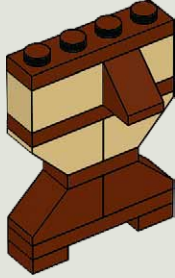

8

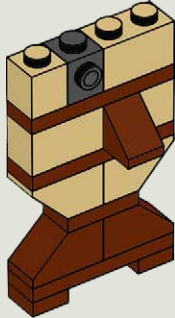

9

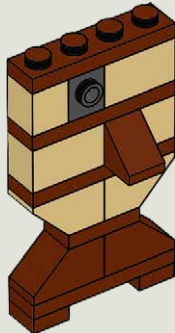



2x
Tan

10

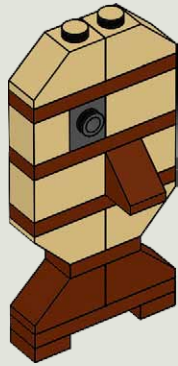

2x
Brown

11

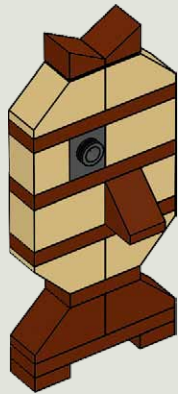

1x
Medium grey

12

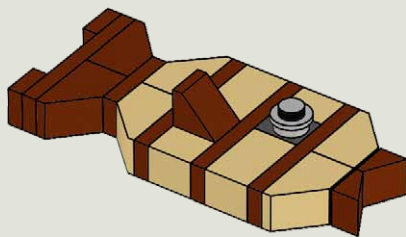

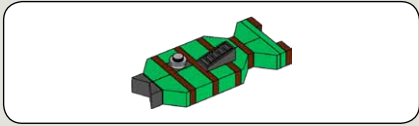

1

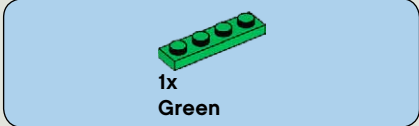
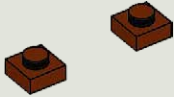

2

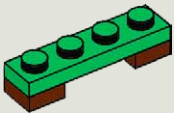

3

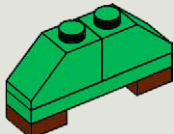

1x
Brown



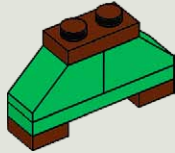

4



2x
Green

1x
Brown



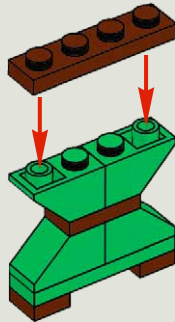

5



1x
Green

1x
Green

1x
Black



6

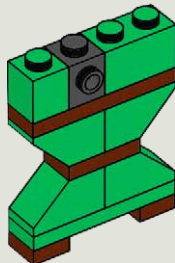

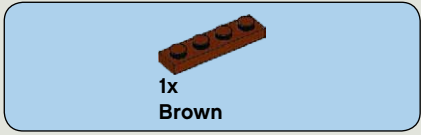

7

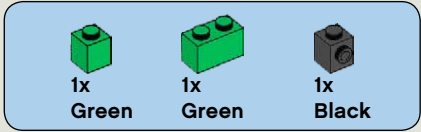
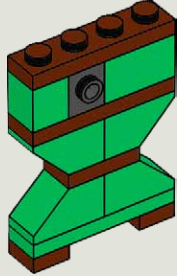

8

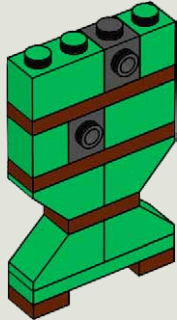

9

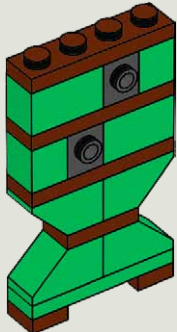



2x
Green

10

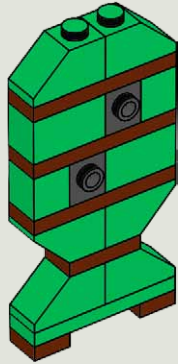

2x
Black

11

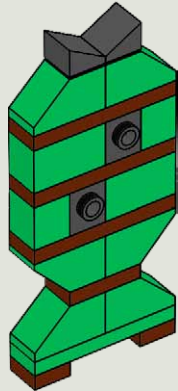

1x

Medium grey



1x

Black

12

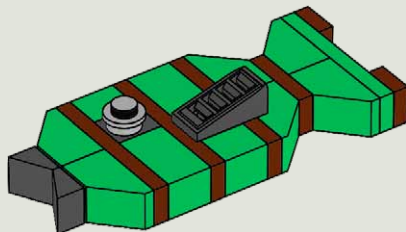

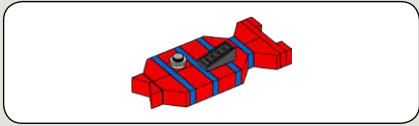

1

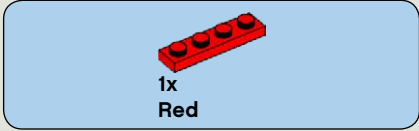
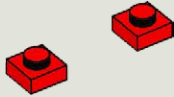

2

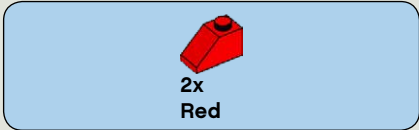
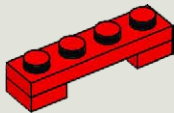

3

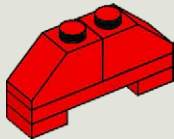



4

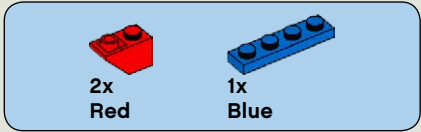
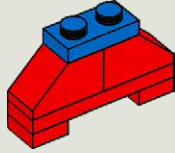

5

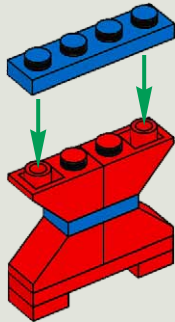

6

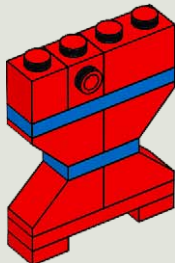

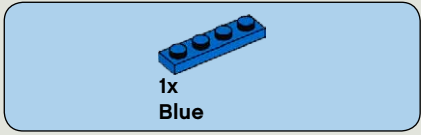

7

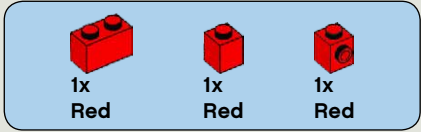
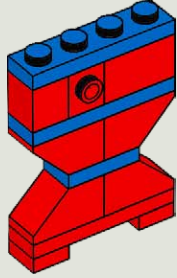

8

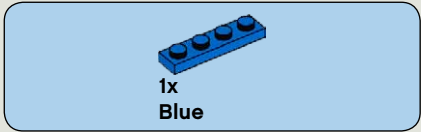
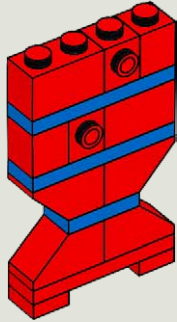

9

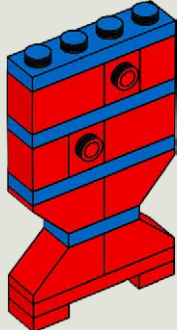

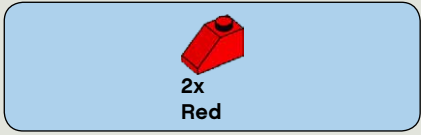

10

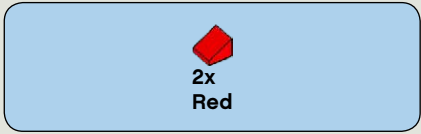
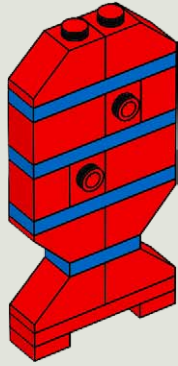

11

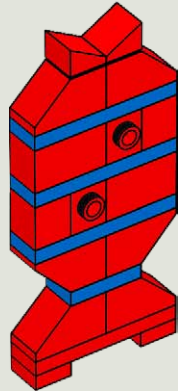

12

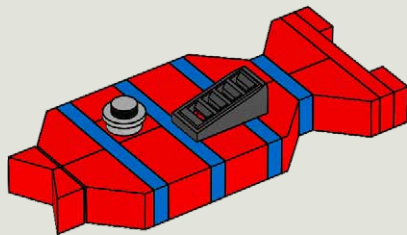
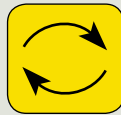

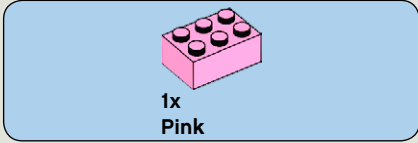
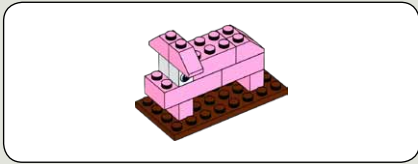

1

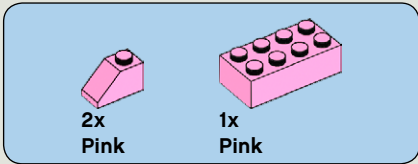
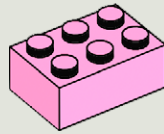

2

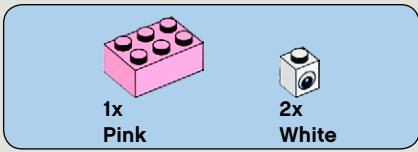
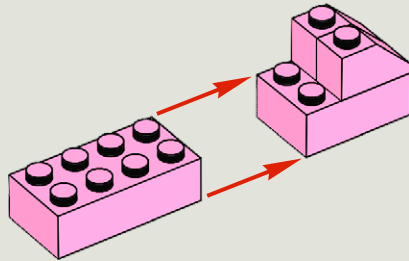

3

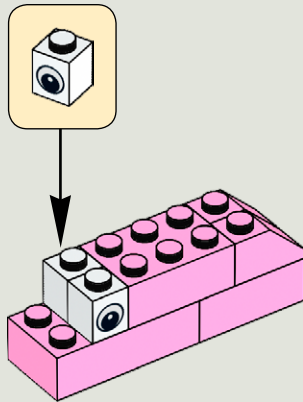

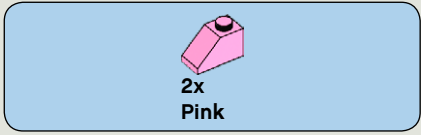

4

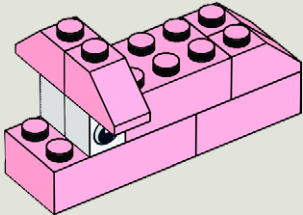

5

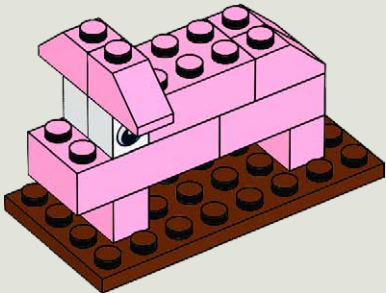
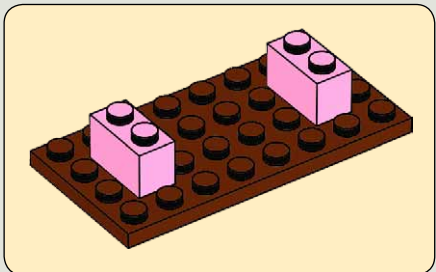

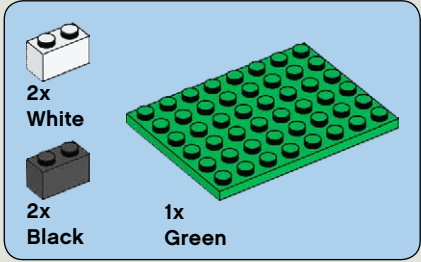
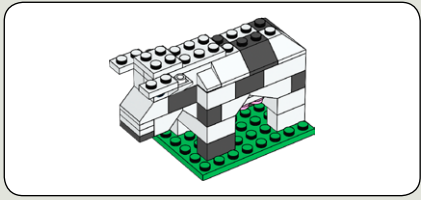

1

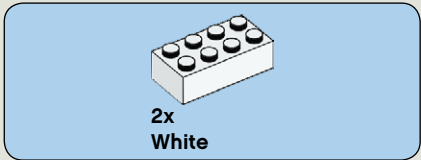
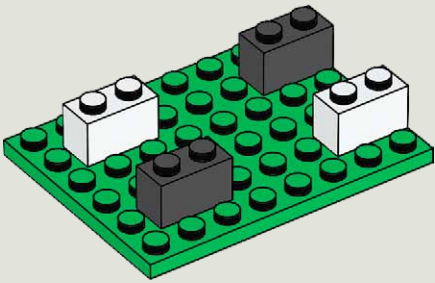

2

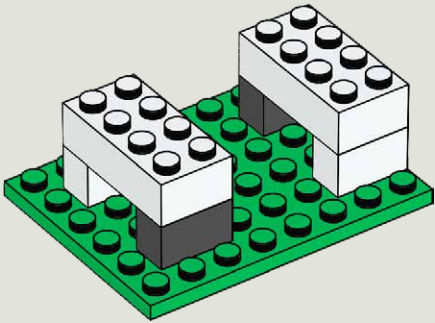

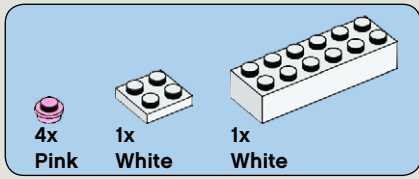

3

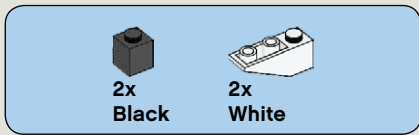
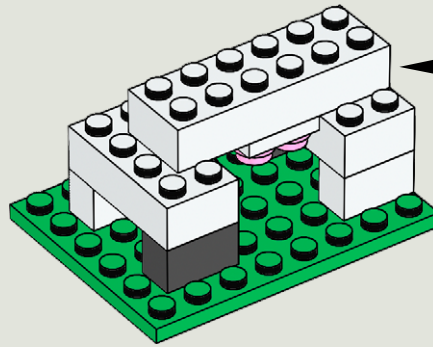
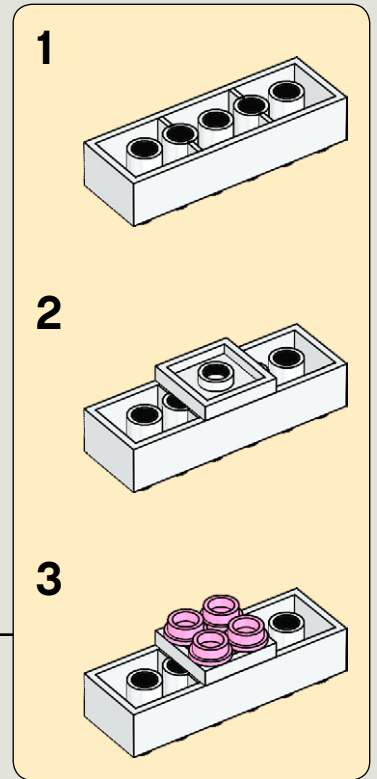

4

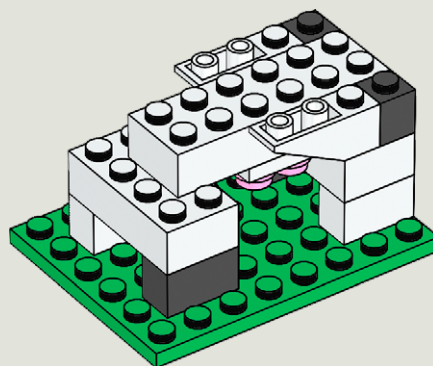

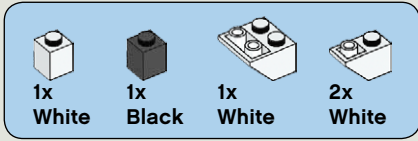

5

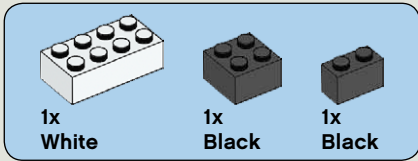
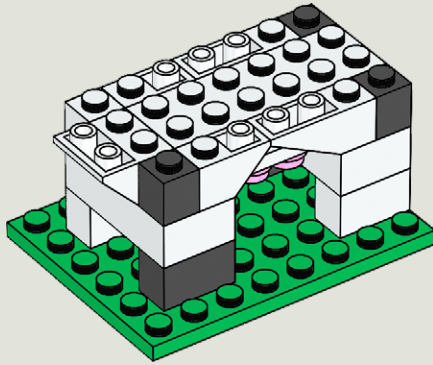

6

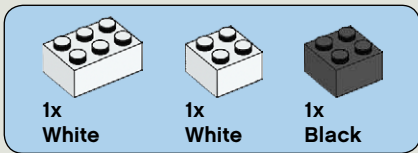
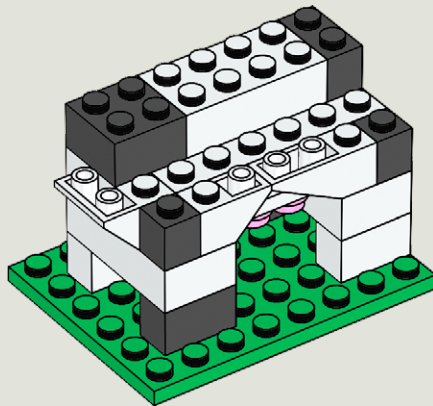

7

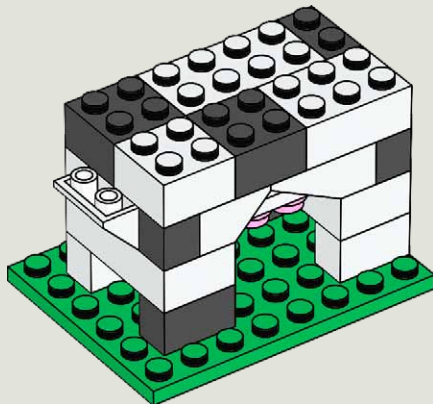

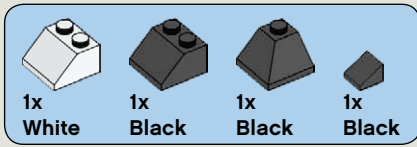

8

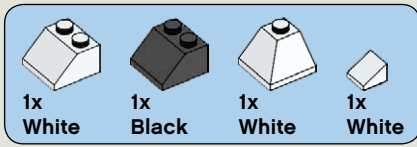
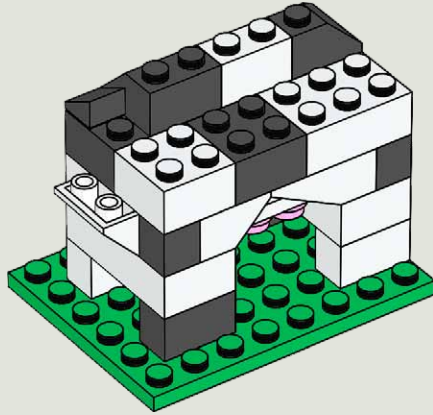

9

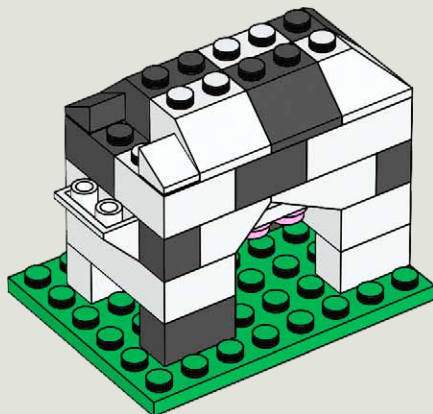

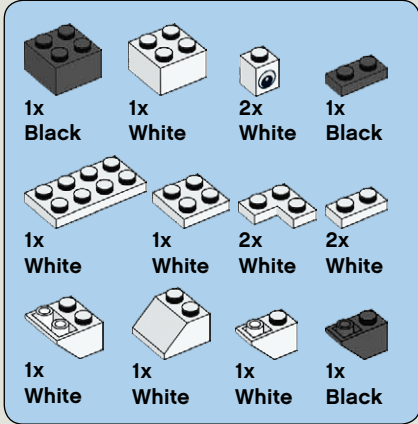
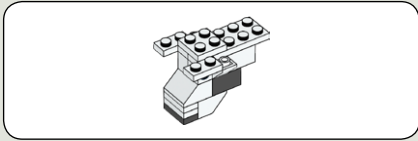

10

1



2

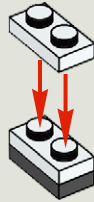

3

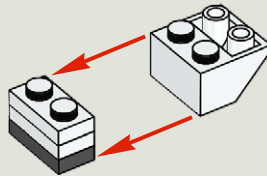

4

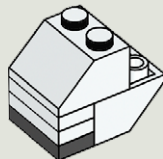

5

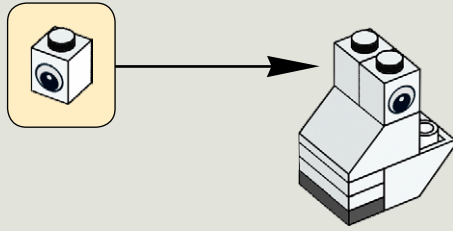

6

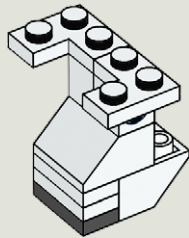

7

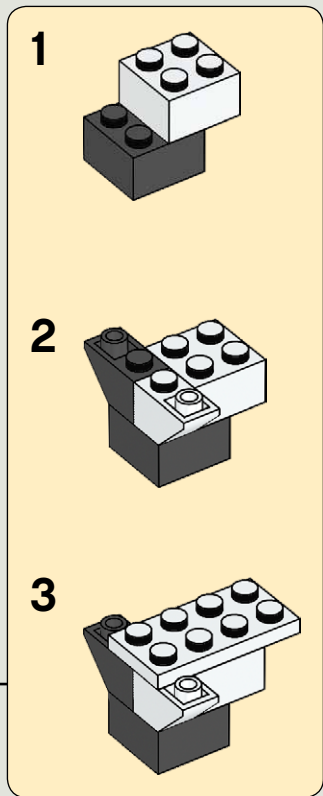
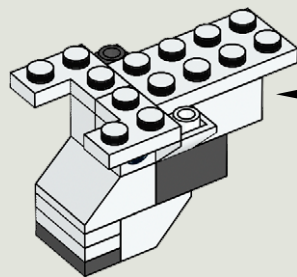

8

